

EXHAUST HEAT RECOVERY

Industrial Spiral Finned Tubing



“Manufacturing Waste Heat Transfer Products To Save Energy”



CAIN INDUSTRIAL FINNED TUBING



Complete Cain Industries heat exchangers can be fabricated to meet a particular replacement size, and your specific performance requirements.

Cain industrial spiral finned tubing can be custom fabricated to suit your specific needs – both in metal specification and in the shape of the formed sections.



Whether it's simple straight lengths, single or double coils, or any complex custom-fabricated shape, chances are Cain Industries can fabricate it for you. We welcome your inquiry.



Cain Industries has many skilled personnel with years of experience to face the challenges of a particular design.



Cain Industries offers an extensive selection of boiler Finned tubing. Its primary function is to maximize the amount of heating surface that can be utilized in a given volume of installation space. As an example when you compare the amount of heating surface within a lineal foot of a 1" OD bare tube to a lineal foot of a 1" OD tube with 6 fins per inch and .5" fin height, you increase the amount of heating surface by a factor of 12. This equates to 12 times more heating surface with a finned tube than a bare tube, per lineal foot. Or it could also be viewed as a finned tube one foot long, which provides the same amount of heating surface as a 12 foot long bare tube.

There are many different types and methods of fin to tube attachment. Cain Industries has accumulated years of experience in the field of waste heat recovery from our industrial combustion exhaust product lines. These product lines include boiler economizers, waste heat recovery silencers, and packaged waste heat boilers – which all utilize finned tubing under rigorous thermal load conditions.

We have determined which specific types of finned tubing can best withstand the extremes of temperature and environment in our customers' installations. As a result we have developed proprietary technology to produce a range of industrial grade products that meet the industry's stringent demands.

When you have a finned tube requirement, we will offer the best recommendation to suit your need at competitive pricing. We'll quote your specification or create a specification based on your exact needs. We can offer basic finned tubing in straight lengths or subassemblies, or a complete heat exchanger.

ASME Quality Control: ASME stamping is available to meet Sec.VIII Div.I ('U' symbol) and Sec.I ('S' symbol) and National Board Stamp.

Sample Designs: Cain Industries will provide prototype finned tubing or assemblies, when required, at a nominal cost.



Standard finned tubing types available:
All are available for rapid quotation and delivery.

- Stainless steel tube to aluminum fin with the Al-Fuse™ bonding method of fin tube attachment for temperatures to 750°F.
- Stainless steel tube to stainless steel fin with Nickel Brazed/welded method of fin tube attachment for temperatures to 1750°F.*
- Stainless steel tube to carbon steel fin with Nickel Brazed/welded method of fin tube attachment for temperatures to 1650°F.*
- Carbon steel tube to carbon steel fin with Nickel Brazed/welded method of fin tube attachment for temperatures to 1650°F.*
- Copper or cupro nickel tube to copper fin with Nickel Brazed/welded method of fin tube attachment for temperatures to 1,750°F.*

Optional protection:

* A Nickel Clad Coating, up to 2 mil thickness, is available to provide extended corrosion protection.

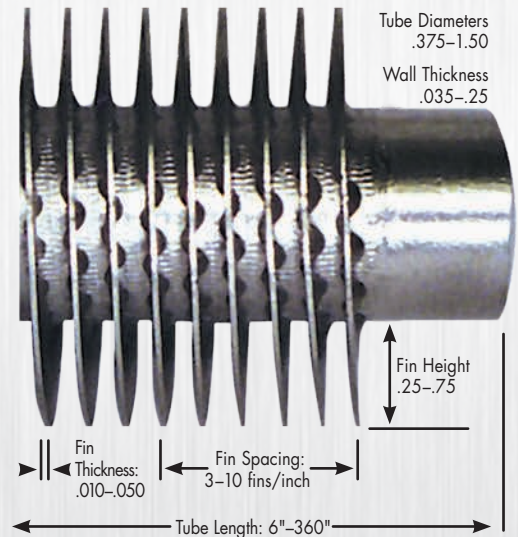

CALL TODAY FOR A PROMPT QUOTATION: 1-800-558-8690



AL-FUSE™ SPIRAL FINNED TUBING

The Al-Fuse™ process bonds aluminum fin to stainless steel or aluminum tube and is available in a variety of tube sizes, fin spacings, heights, and tube and fin metal combinations.

THE EXCLUSIVE AL-FUSE™ BONDING PROCESS

Cain Industries' proprietary metal bonding process called Al-Fuse™ produces a permanent metallurgical bond between the dissimilar metals. One very popular type is aluminum fin bonded to stainless steel tube which assures the original performance at the rated capacity of the spiral finned surface during its lifetime.

Cain's proprietary process incorporates a liquid composition which, when subjected to heat, creates a reaction causing alloying of the metals. The result is an integral one-piece unit possessing maximum heat transfer capability and a protective coating offering high resistance to corrosion.

AL-FUSE CAN EASILY BEND AND TWIST IN AND AROUND CONFINED SPACES.

The finned tubing can be twisted and bent into numerous shapes. By forming a tube length into a U-shape, circle, square, or serpentine configuration, limited space is utilized rather than being wasted.

As fins are metallurgically bonded to tubes, expansion and contraction does not develop points of stress along the tube surface that can cause metal fatigue. And, unlike the "pinging" sounds created by the movement of fins which are mechanically bonded to tubes, expansion and contraction of the Al-Fuse™ tube is noiseless. Vibration and thermal shock will not cause separation of the fin and tube.

- **Highest heat-transfer efficiency**
- **Excellent structural formability**
- **Rugged yet lightweight**
- **Leakproof reliability**
- **High corrosion resistance**



FIN TUBE CROSS-SECTION

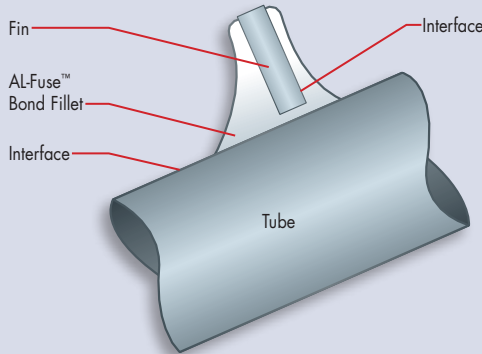

Cain Industries' patented bonding process metallurgically joins stainless steel fins to aluminum tubes for the highest heat transfer efficiency possible. Even when magnified 100x, no voids are revealed in the metallurgical bond. That is your assurance of maximum heat transfer efficiency, and a technological advantage over other types of finned tubing.

Elbows and other fittings can be eliminated or drastically reduced in number as the tube can be bent at any point along its finned surface without reducing its heat-transfer efficiency. A choice of metals affords compatibility with the requirements of numerous applications. Tubing is available in stainless steel, copper, and aluminum. Spiral fin is available in stainless steel, carbon steel, and aluminum.

When ordering or submitting a request for quotation, please use our finned tube specification sheet to properly identify your requirements. Other finned tube materials can be offered as options.

Typical cooling applications which illustrate the versatility of Al-Fuse™ Finned Tubing.

CONVERTER COOLER

With spiral finned tube across the face of the radiator, the engine powered fan cools the engine's jacket water as well as the circulated hot oil.

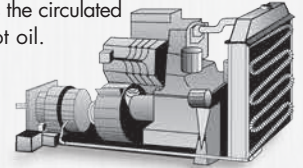

CUSTOM DESIGNED RADIATOR

Straight lengths of spiral finned tubing fitted into top and bottom tanks provide cooling for a closed system. Additional cooling is possible with a powerdriven fan.

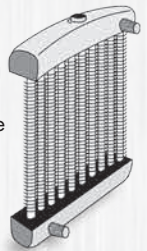

AIR COMPRESSOR

Two short lengths of spiral finned tubing provide the surface required to cool compressor air.

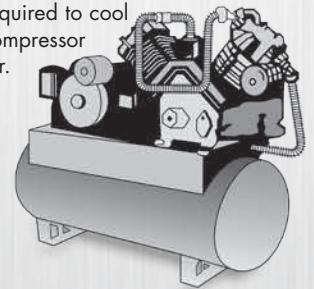

HYDRAULIC POWER SUPPLY

Life of power source is lengthened by removing excess heat from hydraulic fluid used with machine tools. Hot fluid is cooled as it circulates through spiral finned tube placed in the path of the engine's combustion air supply.

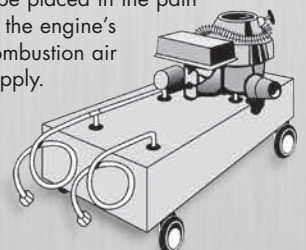

MARKET SPECIFIC PRODUCT LINES



PRODUCT APPLICATION:

Combustion Sources: Gas engines (reciprocating, turbo charged, naturally aspirated, and rotary), diesel engines, micro-turbine & gas turbine engines

ESG1

Capacity: 400kW – 7MW
 Entering Gas Temps.: 500 – 1,250°F
 Heat Sink Types: Supplemental steam demand and/or primary steam source for steam heating or process steam

HRSR

Capacity: 200kW – 7MW
 Entering Gas Temps.: to 1,250°F
 Heat Sink Types: Engine jacket water, process water, boiler water, ethylene glycol

UTR1

Capacity: 200kW – 10MW
 Entering Gas Temps.: to 1,600°F
 Heat Sink Types: Process water, boiler feedwater, ethylene glycol, thermal transfer fluids

HRSA

Capacity: 5 – 150kW
 Entering Gas Temps.: 400 – 1,600°F
 Heat Sink Types: Engine jacket water, process water, boiler water, ethylene glycol

UTR

Capacity: 15 – 300kW
 Entering Gas Temps.: 400 – 1,600°F
 Heat Sink Types: Engine jacket water, process water, boiler water, ethylene glycol

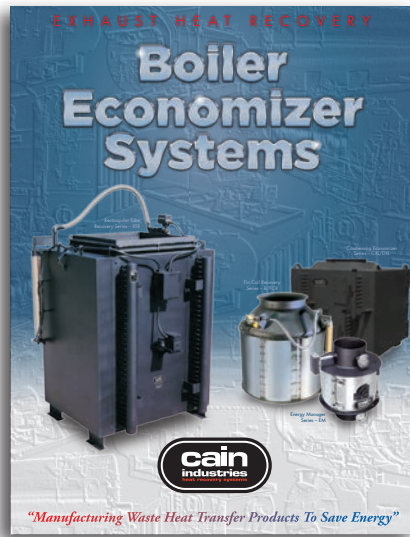

PRODUCT APPLICATION:

Combustion Sources: Steam boilers, hot water boilers, dryers, ovens, hot oil heaters

RTR

Combustion Capacity: to 250,000 pph (300,000,000 Btu/hr maximum input approx.)
 Entering Gas Temps.: 300 – 800°F
 Heat Sink Types: Boiler feedwater, makeup water, hot water return, hot water storage tank, condensate tank, process water

FCR

Combustion Capacity: 50 – 10,000 scfm
 Entering Gas Temps.: to 800°F
 Heat Sink Types: Boiler feedwater, process water, thermal fluids, run-around systems.

B-SERIES

Combustion Capacity: 40 – 800 Bhp
 Entering Gas Temps.: 300 – 700°F
 Heat Sink Types: Boiler feedwater, hot water return, hot water storage tank, condensate tank, process water

EM

Combustion Capacity: 200,000 – 6,400,000 Btu/hr input
 Entering Gas Temps.: 300 – 700°F
 Heat Sink Types: Boiler feedwater, hot water return, hot water storage tank, condensate tank, process water

CXL & DXL

Combustion Capacity: to 250,000 lb/hr steam
 Entering Gas Temps.: 300 – 800°F
 CXL Heat Sink Types: makeup water, process water
 DXL Heat Sink Types: Boiler feedwater, makeup water, hot water return, hot water storage tank, condensate tank, process water

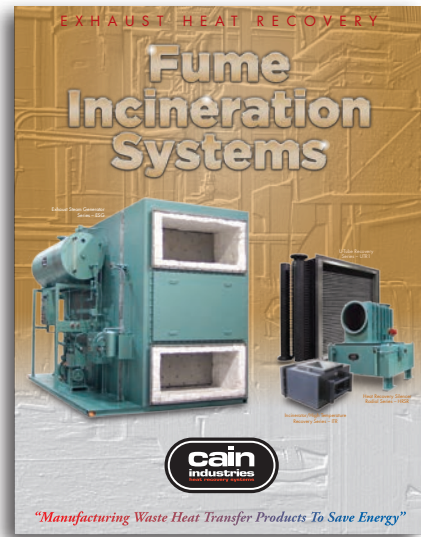

PRODUCT APPLICATION:

Combustion Sources: Incinerators, thermal oxidizers, catalytic convertors

ESG

Combustion Capacity: 1,000 – 50,000 scfm
 Entering Gas Temps.: 600 – 1,600°F
 Heat Sink Types: Supplemental steam demand and/or primary steam source for steam heating or process steam

HRSR

Combustion Capacity: 500 – 20,000 scfm
 Entering Gas Temps.: 450 – 1,250°F
 Heat Sink Types: Engine jacket water, process water, boiler water, ethylene glycol

ITR

Combustion Capacity: All load conditions
 Entering Gas Temps.: 1,250 – 2,000°F
 Heat Sink Types: Process water, boiler feedwater, hot water return, potable water, hot oil

UTR1

Combustion Capacity: 200 – 50,000 scfm
 Entering Gas Temps.: 450 – 1,600°F
 Heat Sink Types: Process water, boiler feedwater, ethylene glycol, thermal transfer fluids

Your Authorized Cain Representative



PO BOX 189 • W194 N11826 MCCORMICK DR. • GERMANTOWN, WI 53022
 262-251-0051 • 800-558-8690 • SALES@CAININD.COM • WWW.CAININD.COM